

Neural Networks Technology for Evaluating Solar Energy Resources in Tashkent

Raman Kulinich^{a,b}, Uladzimir A. Sednin^b, Kamol Komilov^c, Dildora Makhmudova^d

^aSchool of Energy Science and Engineering, Harbin Institute of Technology (HIT), 92 West Dazhi Street, Harbin 150001, PR China

^bIndustrial Power and Heat Engineering Department, Power Engineering Faculty, Belarusian National Technical University (BNTU), Nezavisimosty Ave, 65, building 2, Minsk, Belarus, 220013

^cBelarusian National Technical University

^dTashkent Institute of Architecture and Civil Engineering, Tashkent, Uzbekistan,.

^dE-mail: dildoram76@mail.ru

Article History: Received: 11 January 2021; Revised: 12 February 2021; Accepted: 27 March 2021; Published online: 16 April 2021

Abstract: In terms of economy, electricity is a commodity capable of being bought, sold and traded. Electricity is difficult to store, and it has to be available on demand. Consequently, unlike other products, it's impossible, under normal operating conditions, to keep it in stock, to ration it, or to have customers queue for it. The solar energy generating system, whether grid-connected or stand-alone, is most commonly used in places when possible to install solar equipment (roofs, pollutes areas, closed rubbish dumps, rural and suburban areas). It is based on converting solar radiation (i.e., photons that are sent from the sun) to produce electricity. The PV system has a lot of ways of applications. For example, in developing countries, PV is used for basic life needs, such as heating and cooking, while in developed countries, the system is used to supply electricity for homes and grids. Due to its importance in the solar energy field, global solar radiation data (GSR) forecasting has become more popular to facilitate solar system installation. Solar radiation prediction and forecasting carry out considering global weather solar radiation data. Ambient temperature and relative humidity data are the most commonly used parameters to predict solar radiation and special techniques used in this study are artificial neural networks

Keywords: energy forecasting; solar energy prediction; artificial neural network; global solar radiation; average air temperature.

1. Introduction

The Brief History Of Solar Energy Use

In Uzbekistan, for many decades, attention has been paid to the solar energy researches. The first development in the field of solar energy in Uzbekistan began nearly 80 years ago, in the past 1932, when a laboratory of solar engineering was created in Samarkand. During 1940 and 1950s the first parabolic concentrator was built and the scientific investigations were commenced on solar energy conversion into electricity, after that the first photovoltaic installation was built. In 1943, The physical-technical institute (PhTI) was organized, which was the first academic institution engaged in extensive research in the field of physics and engineering in a territory of Central Asia.

In 1986, the Institute of Physics-Sun was organized on the basis of The physical-technical institute. In 1987 a unique optical mirror complex with a big solar furnace, which thermal power is 1 MW was put into operation. Since 1965, The physical-technical Institute of Physics-Sun has been publishing The international journal "GELIOTEHNIKA". The journal is translated into English by the company "Allerton Press" (USA) and it is published in the United States under the name "Applied Solar Energy".

Nowadays situation with solar energy in Uzbekistan

Renewable energy is an integral part of the energy development in Uzbekistan in the context of the overall national policy. In particular, the State plans to increase the share of renewable sources of energy (hereinafter – "RSE") to 25% by 2030 and, thus, takes active measures in the implementation of promising projects in this industry.

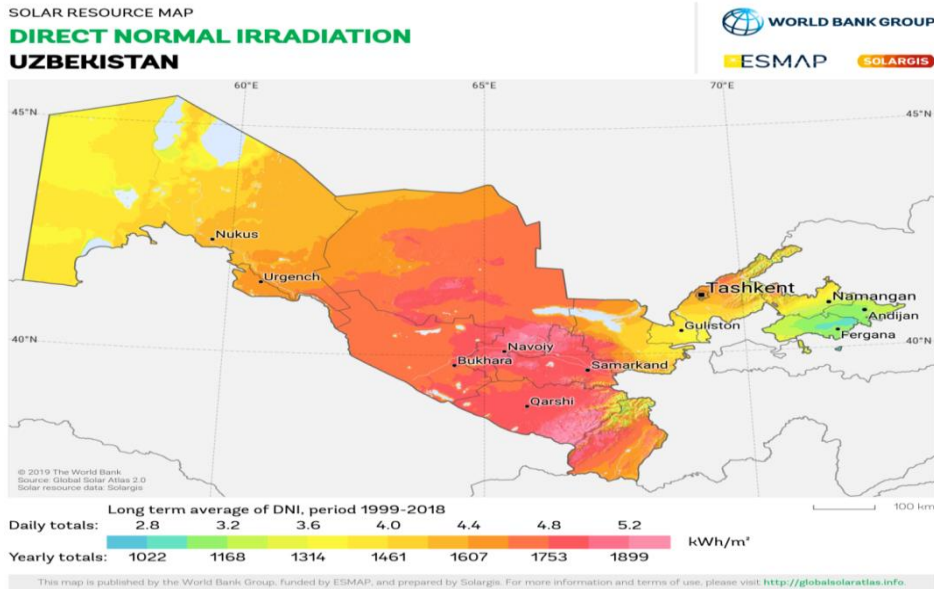

Fig.1 Global Horizontal irradiation(Uzbekistan part).Image: solargis.info.

According to the Decree of the President of the Republic of Uzbekistan dated 01.03.2013, №4512 "On measures for further development of alternative energy sources", principal attention is being paid to broader use of solar energy and biogas. Because, nowadays there exist all means to implement projects in these directions in all territory of Uzbekistan.

In addition, on February 1, 2020, the Ministry of Energy with the support of the Asian Development Bank (ADB) announced the launch of the first pilot project for the construction of SPS in the Sherabad district of Surkhandarya region. Due to this project, the SPS with a capacity of at least 200 MW, a 220 kV substation and a 52 km long power transmission line will be built. At the moment, 54 companies have submitted applications for participation in the tender, which indicates a high increase in investor interest in implementing projects in Uzbekistan in the field of renewable energy.

Also the agreement was signed with the French company "Total Eren" for the construction of a 100 MW SPS in Nurabad district of the Samarkand region.

Moreover, the Canadian company Sky Power Global plans to install several SPSs with a capacity of about 1 GW in Uzbekistan, while the total investment is estimated at \$ 1.2-1.3 billion.

The state's strategy is to bring the SPS capacity to 2 GW, and the capacity of all solar power generation to 7,000 MW with the support of the IFC and ADB based on the PPP mechanism.

According to the potential of solar energy of Uzbekistan difficulties with connection solar parks and electric grid operator becomes actual. So, technologies of Artificial neural networks come to solve this problem.



Human brains interpret the context of physical real-world situations in a way that computers can't make it. The first steps in Neural networks were made in the 1950s to address this issue. An artificial neural network is a conception to simulate the network of neurons that make up a brain of brain so that the computer will be able to learn things and make decisions in a human-like manner. ANNs are created by programming regular computers to behave as though they are interconnected brain cells. A neural network (NN) is a program that is designed to imitate the human brain. The brain consists of many neurons, which are connected by axons, synapses, and dendrites. The neurons are composed of neurons that are linked by weights and biases. The function of a neural network is to map the relationship between the input(s) and the output(s). Neural networks can be used for different functions, such as curve fitting, prediction, and regression [2]. In this paper, neural networks are used to design forecasting models, using four steps, such as collecting data, initiating network, training data, and simulating data. Location of investigation: Republic of Uzbekistan, Tashkent city (Location: Latitude 41.3082 Longitude 69.2598) is selected as the case study.

The design of any neural network model requires information about the system that will be used. In our case here, information about radiation, temperature, humidity, atmospheric pressure in the area of Harbin, is collected from internet-source [3]. After data array completion, it will be entered into the initiation stage, where data is dividing and processing. During the stage of division, data are divided into three sets: training set, validation set, and testing set. After that, the data are ready to train the process and simulate prediction results. The solar power forecasting can be performed by several methods. Two significant categories: the cloud imagery, which is combined with physical models and machine learning models. The choice of method depends mainly on the prediction horizon. All of the models have not the same accuracy of terms of the horizon used. Various approaches exist to forecast solar irradiance depending on the target forecasting time [4, 5, 6].

2. Methods

The core unit of an artificial neural network is neurons, which use the transfer function to create output. Each input (p) is multiplied by a weight (w), which serves as a connection between an input and a neuron as well as between the various layers of neurons. In the next stage, weight inputs are combined, after which a bias (b) is added to the sum of the weight inputs. [14] The neuron applies a transfer function (n) to this result, from which the output (a) is obtained. Figure1 illustrates a simplified flow chart of the artificial neural network.

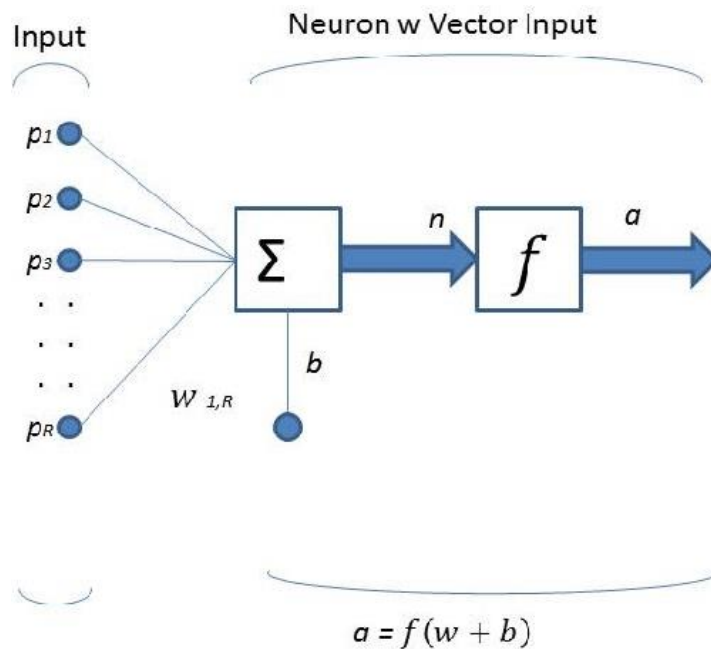

Fig.1 Simplified flow chart of artificial neural network

Road to aim:

Access and load the data. Preprocess the data. Derive feature, using the preprocessed data. Train models, using the features derived. Iterate to find the best model. Integrate the best-trained model into a production system.

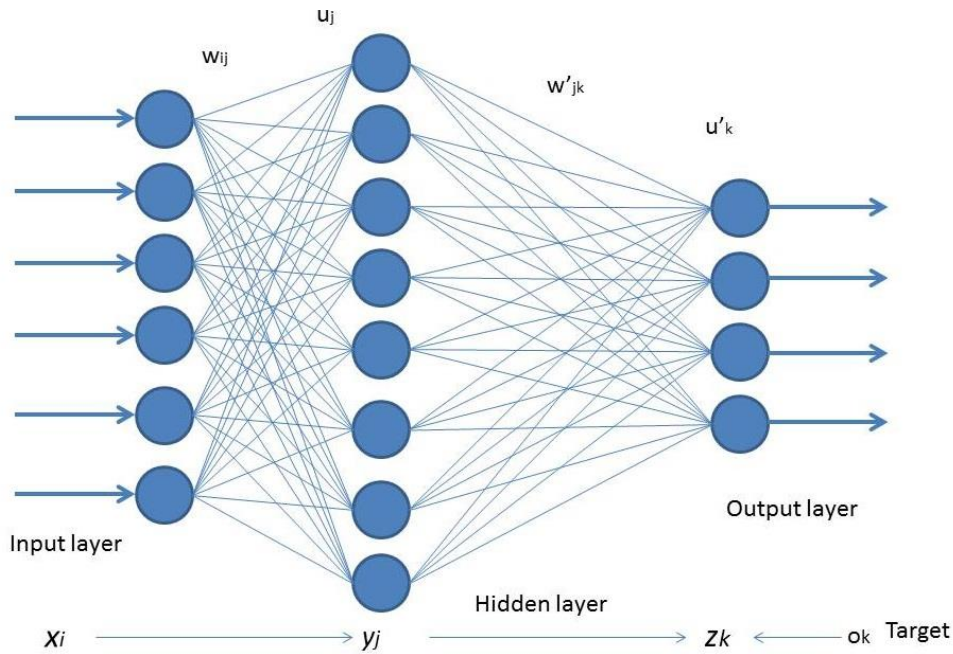

Fig.2 Flow chart of three-layer feed-forward neural network

Neural networks consist of simple elements, which operate in parallel. These elements are inspired by biological nervous systems. As in nature, the network function is determined largely by the connections between elements [15]. A neural network can be trained to perform a particular function. It is possible by adjusting the values of the connections (weights) between the elements. Commonly neural networks are adjusted or trained, so a particular input leads to the special target output. Such a situation is shown in Figure 1. Here, the network is adjusted, based on the comparison between the output and the target, until the network output matches the target. Typically, many such input/target output pairs are needed to train a network [16, 17].

The purpose research is to determine the best renewable energy source for generating electricity in Tashkent. For this aim, Matlab Neural Network Toolbox is a suitable program for determining the future amount of solar energy by past time information.

Work scheme #1

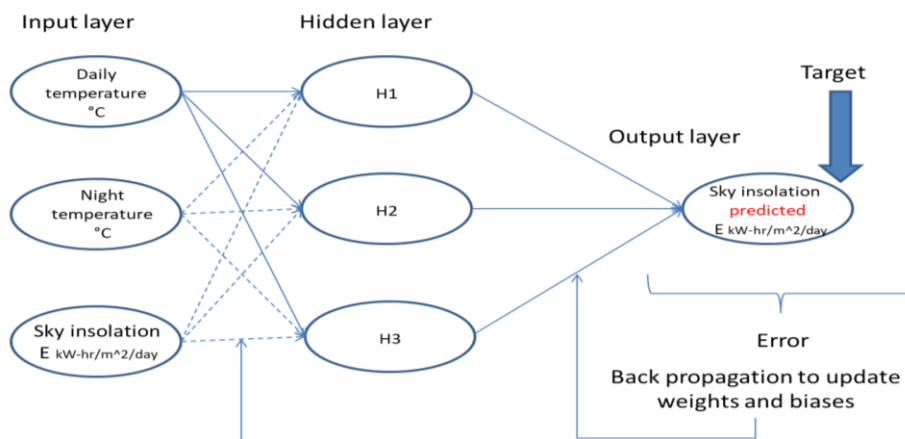

Fig.5 Work scheme #1. Input: Daily temperature, night temperature and solar sky insolation. Output-solar insolation

In this study, 1 types of weather data are considered for appropriate parameter settings:

Massive array from September 2014 till September 2018.

Maximum and minimum day’s temperatures and numbers of the days according to ordination number: (1, 2, 3...365; 1, 2, 3...366; ...). That considered as input. To be confident that calculation isn’t mistaken, the model is created over the period from Sept. 2014 to Sept. 2018 data. This period’s data can be considered as the data of

“past”. While Sept. 2018 is “now”. Thus, that allows us to compare the predictions of the period from 2018 to 2019 with real data.\

3. Results and discussion.

Performance of Neural Network Training

Analysis of regression is a statistical method used to measure errors between training and validation sets. Regression analysis studies whether the variables used are dependent or independent with regards to system response. In this study, the evaluation of generalization performance is calculated by the correlation coefficient (R-value), a value that indicates the relationship between the network output response and the corresponding target in a linear fit line. If the value is closer to one, the correlation between the target and the output is strong [18,19].

Figure 7 clearly describes the net radiation 2018-2019 model. Input consists of 3 types of data-array:

- the average daily temperature of air;
- the average nightly temperature of air;
- the number of the days.

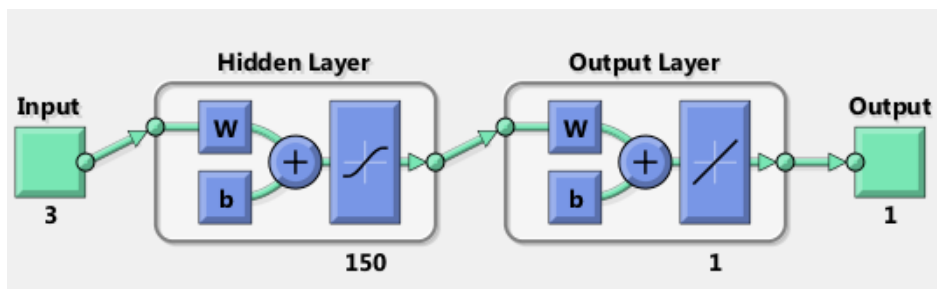

Fig.7 Net radiation 2018-2019 model

The number of hidden neurons was chosen using a trial-and-error procedure, and the best number was found to be 150. The *Output* consists only of solar radiation data 2014-2018 year, which we “know”. This step allows the program to find an algorithm that shows the dependence between input and output data. After that, we get *Output1*, which consists of similar data with input. Of course, *Output1* has an error.

Figure 8 describes the comparison of original solar radiation and predicted solar radiation between 2014-2018 years. The deviation observed between the original radiation and the predicted one could be attributed to the errors. Some places have technical errors (see figure 8; 9). Moreover, original solar radiation data and predicted solar radiation data for 5 years is shown in Figure 8; 9.

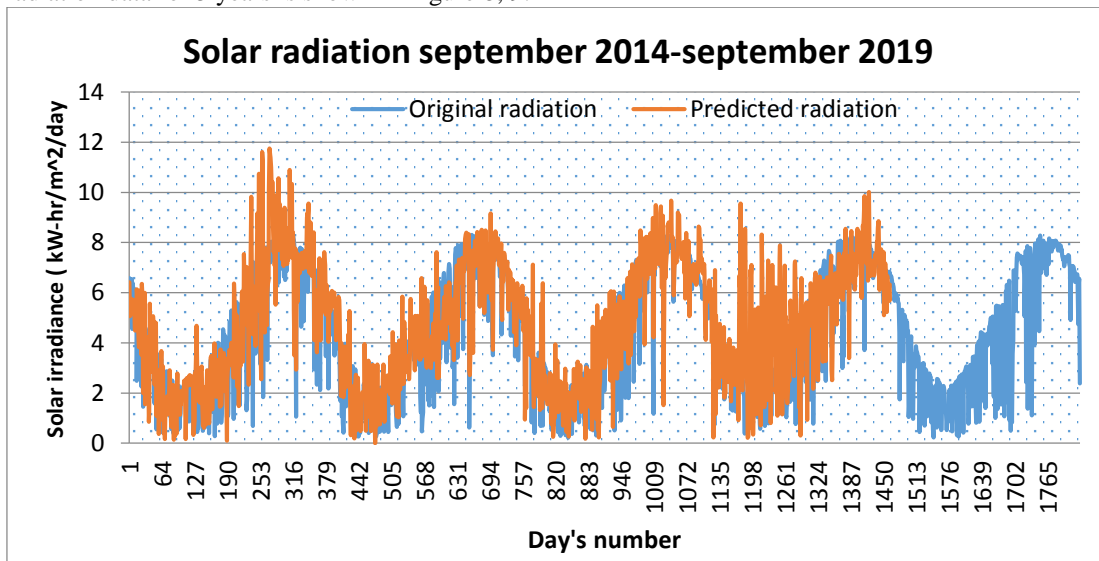

Fig.8 Predictions of period from September 2014 till September 2019: red color massive is our Original solar irradiance data kW-hr/m²/day (data which was taken from weather resource). Blue color massive is our Predicted solar irradiance data (which was predicted by ANN technology)

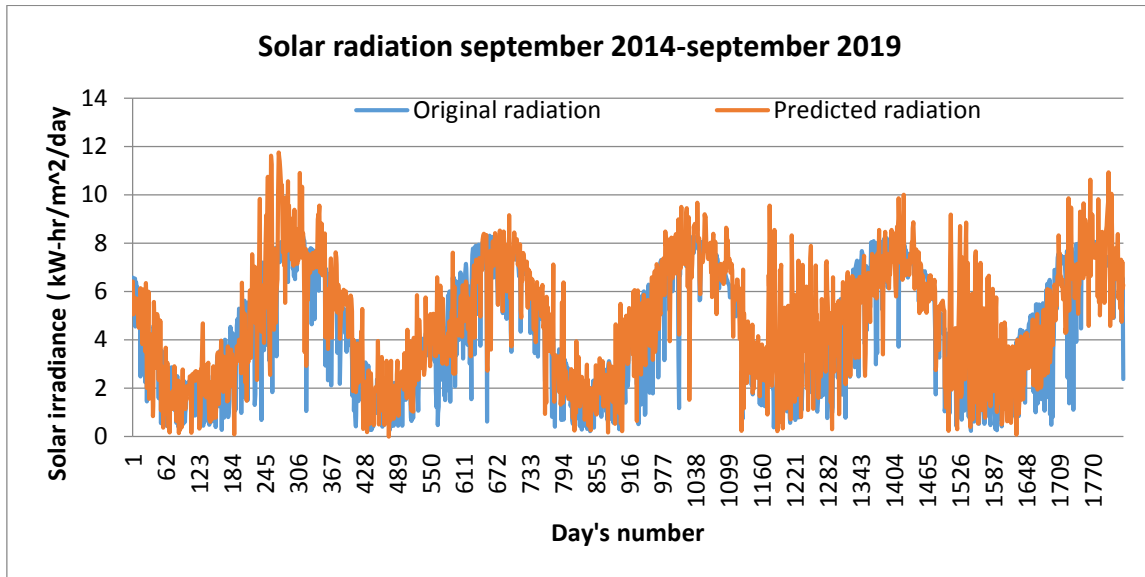

Fig.9 Predicted data (Blue) Vs. Original data (red); stratification

“Figure10” shows comparison of original solar radiation and predicted solar radiation between 2018-2019. As can be seen in “Figure10”, we can detect a form of 2018-2019-years solar radiation prediction. It is almost similar to the previous year’s parts. It gives us insight that our prediction is plausible. Peaks of the graph are only in the summer. The peak of predicted part is the summer period too. “Figure 11” shows the original solar radiation data and predicted solar radiation data for 5 years. It doesn’t have any extreme vertical drops.

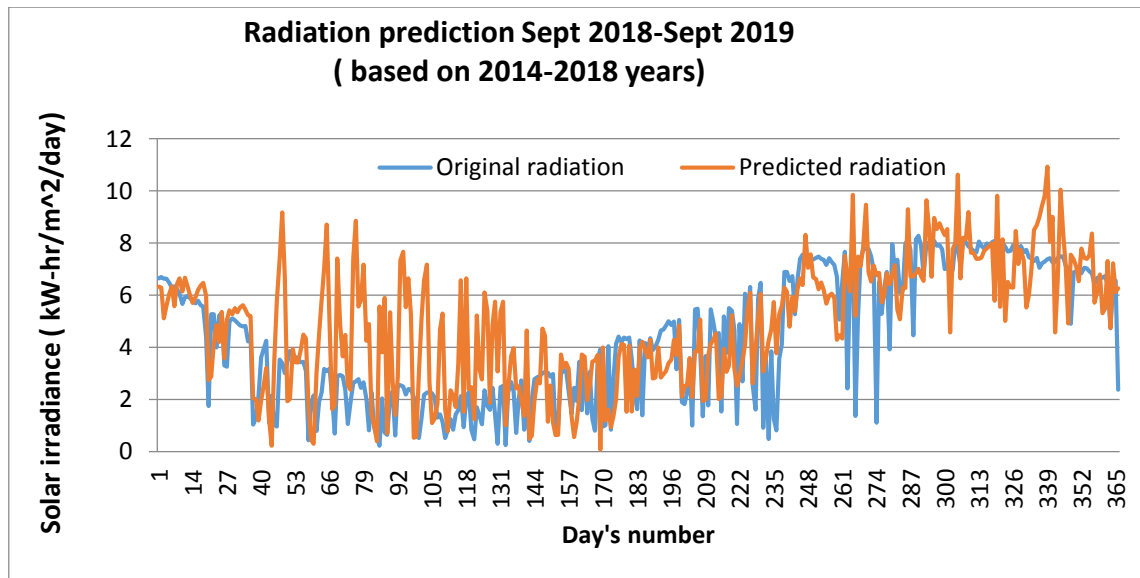

Fig.10 Original solar radiation (red) (2018-2019) and predicted solar radiation (blue) data (2018-2019)

Solar energy is an inexhaustible and renewable source of energy. The main necessary conditions for the development of solar energy are: long daylight hours, the prevalence of sunny weather in the daytime and a high angle of incidence of sunlight [22, 23].

On this basis, the most favorable development regions are countries in tropical and subtropical climatic zones. However, for industrial sphere use, a major drawback is that the intensity of solar radiation is dependent on weather conditions and the time of day.

Due to the impermanent nature of renewable energy sources, the task of forecasting the volumes of generated solar energy is relevant.

The forecasting task is one of the most complex tasks of data analysis and requires careful analysis of the source data, identifying patterns in them, as well as selecting informative features. The initial data for the task of forecasting solar energy is long-term statistics containing information on weather conditions and the daily solar irradiance data [24, 25].

The goal of the research was to find accurate method of predictions solar radiation, to predict the daily average of global solar radiation in Tashkent, Uzbekistan. This research discusses the results obtained from the ANN model. Solar radiation is an essential parameter for implementing solar energy systems.

The proposed method has ability to do future solar energy forecasting according to collected data:

- Method is fully informative and based on the current instrumentation of Artificial Intelligence.
- Application is simple and understandable for engineers.
- It has a big research backup for improving our method (increase input, decrease error, add new algorithms of predictions, etc.)

It may be difficult or impossible to propose a generalized ANN model that can be used for any PV plant. But it's still possible to give better results for a different data set even it shows poor performance in this study. The relationship between weather parameters and the generated power may change with the region, the design and construction of the power plant.

Table 3 Error situation (based on 2014-2018 years of data)

Date of day	Value of predicted solar radiation, kWh/m ² -day	Value of original solar radiation, kWh/m ² -day	Error percent, %
01/09/2018	6,65	6,32	5%
02/09/2018	6,7	6,29	6%
03/09/2018	6,64	5,11	23%
04/09/2018	6,64	5,58	16%
05/09/2018	6,48	6,05	7%
06/09/2018	6,29	6,34	1%
07/09/2018	6,34	5,58	12%
08/09/2018	6,23	6,43	3%
09/09/2018	6,06	6,65	10%
10/09/2018	5,67	6,14	8%
11/09/2018	5,92	6,66	13%
12/09/2018	5,98	6,33	6%
13/09/2018	5,89	5,99	2%
14/09/2018	5,8	5,70	2%
15/09/2018	5,69	5,93	4%
...

According to the results of “Table 4”, we can catch the dynamics of predictions. It has a positive dynamics, but it isn't ideal. Of course, the method of prediction can be changed by adding new data as daily cloudiness, humidity, atmospheric pressure, and others. According to obtained results, predictions can be made for long periods. But it needs high-quality input-information for getting small error results. Common artificial neural network is the basis of science development. Due to the rapid progress of technics, human can no longer control everything everywhere. So artificial intelligence becomes a player of the main role in the nowadays industrial world.

4. Conclusion

Global solar radiation forecasting plays a significant role in the design of solar power systems [26]. In this work, the method was employed to predict daily average solar radiation. This section provides conclusions of the results obtained along with suggestions for future work. In this study, the goal was to find a method that accurately predicts global solar radiation, to predict the daily average of global solar radiation in the area of Tashkent. This research discusses the results obtained from the ANN model used four types of weather data.

Artificial neural networks, in collaboration with solar energy, are good basis for implementing and exploiting effective solar power generation systems.

References

1. M. Woolfson. The origin and evolution of the solar system. *Journal of Astronomy & Geophysics*. 2000, 41: 150.
2. S. Panteliou, A. Dentsoras, E. Daskalopoulos. *Journal of Solar Energy*. 1996, 57: 1.
3. D. Basak, S. Pal and D. C. Patranabis. Support vector regression. *Neural Information Processing-Letters and Reviews*. 2007, 11: 203–224.
4. S.Shubbak, H. Mahmood. The technological system of production and innovation: The case of photovoltaic technology in China. *Journal of Research Policy*. 2019, 48: 993–1015.
5. X.Yang, H. Hanjun, T. Tianwei, L. Jinying. China's renewable energy goals by 2050. *Journal of Environmental Development*. 2016, 20: 83–90.
6. J.A. Duffie, W. A. Beckman. *Solar Engineering of Thermal Processes*[M]. John Wiley and Sons, New York, NY, USA, 2nd edition, 1991.
7. Akbarzadeh, J. Andrews, P. Golding. Solar pond technology: A review and future directions. *Journal of Advances in Solar Energy*. 2005, 10: 54.
8. E.Sharkawi, A. Mohamed. *Electric energy*. CRC Press. 2005, 13: 87–88.
9. C. Erdem, P. Cuce. A comprehensive review on solar cookers. *Journal of Applied energy*. 2013, 102: 1399.
10. J. Chaves. *Introduction to Nonimaging Optics*, Second Edition. CRC Press. 2015, 11: 5.
11. L.Anjaneyulu, E.Kumar, A. Sankannavar, K. Kesava. Defluoridation of drinking water and rainwater harvesting using a solar still. *Industrial & Engineering Chemistry Research*. 2012, 51: 8040–8048.
12. S. Abanades, G. Flamant. Thermochemical hydrogen production from a two-step solar-driven water-splitting cycle based on cerium oxides. *Journal of Solar Energy*. 2006, 80: 1611–1623.
13. S. Abanades, A. Legal, A. Cordier, G. Peraudeau, G. Flamant, A. Julbe. Investigation of reactive cerium-based oxides for H₂ production by thermochemical two-step water-splitting. *Journal of Solar Energy*. 2010, 45: 4163–4173.
14. E. Bilgen. Solar hydrogen production by direct water decomposition process: A preliminary engineering assessment. *Journal of Hydrog Energy*. 1984, 9: 53–58.
15. J.Wang, S.Yang, C.Jiang, Y. Zhang, P. Lund Status and future strategies for Concentrating Solar Power in China. *Journal of Energy Science & Engineering*. 2017, 5: 100–109.
16. K. Lee, Y.Cha, J.Park. Short Term Load Forecasting Using an Artificial Neural Network. *Journal of Transactions on Power Systems*. 2012, 1: 7.
17. Eluyode, D. Akomolafe. Comparative Study of Biological and Artificial Neural Networks. *European Journal of Applied Engineering and Scientific Research*. 2013, 2: 36–46.
18. S.Adnan, E. Ozalpa, M. Agclarc. Forecasting based on neural network approach of solar potential in Turkey. *Journal Renewable Energy*.2005,30: 1075–1090.
19. Adams, W.Grylls; R. E. Day. *Philosophical Transactions of the Royal Society of London. Journal of Biological Sciences*.1977, 167: 313–316.
20. M. Hossain, A.Maung, B. M. Shawkat Ali. Hybrid prediction method for solar power using different computational intelligence algorithms. *Journal of Smart Grid and Renewable Energy*. 2012, 20: 77–85.
21. T. G. Barbounis, J. B. Theocharis, M. C. Alexiadis, P. S. Dokopoulos. Long-Term Wind Speed and Power Forecasting Using Local Recurrent Neural Network Models. *IEEE Transactions on Energy Conversion*. 2006, 21: 273–284.
22. J. M. Gordon, T. A. Reddy. Time Series Analysis of Hourly Global Horizontal Solar Radiation. *Journal of Solar Energy*. 1988, 41: 423–429.
23. J. Liu. Research on optimal strategy of wind PV-ES hybrid operation in electricity market. *Journal of electric power science and technology*. 2017, 32: 11–15.
24. C. Chen, S. Duan, T.Cai, B. Liu. Online 24-h solar power forecasting based on weather type classification using artificial neural network. *Journal of Solar Energy*. 2011, 85: 2856–2870.
25. J. Wu, C. Chan. Prediction of hourly solar radiation using a novel hybrid model of ARMA and TDNN. *Journal Solar Energy*. 2011, 8: 808–817..